

PASSENGER CARRIERS
FORD **TRANSIT**



MinibusLeasinguk.co.uk

POWERED BY OVL GROUP LIMITED

**Call us now
01491 615516**

Ford



Go Further



Visionary. Ingenious. Remarkable.
Every vehicle bears his signature.

Henry Ford



Travel in safety and comfort.

When it comes to moving passengers quickly, safely and in comfort, there's no smarter choice than the Ford Transit Minibus range. Bigger, brighter and more versatile than ever, it's the purpose-built minibus that puts people first.

Model shown above is a Ford Transit Minibus 14/15 seat L3 H2 Trend in Tectonic Silver metallic paint (option) with 16" alloy wheels. (option).
Model shown (right) is a Ford Transit Minibus 14/15 seat L3 H2 Trend in Deep Impact Blue metallic paint (option) with 16" alloy wheels (option).



Access made easy.

Laid out with offset double seats on one side of the aisle and single seats on the other, the factory-built Transit Minibus M2 offers unrestricted access to the passenger compartment. An extra-wide sliding side door provides two regulation-size exits (as defined under ECE Regulation 107.05) for easier entry and exit. All models feature a power-operated side step, and passenger assist handles conveniently located on both sides of the side door.

Features include

- Spacious and comfortable interior
- Single/double seat layout with straight aisle
- Wide kerbside sliding door
- Power-operated side step
- Passenger assist entry/exit handles
- Low entry height
- Regulation-size exits
- Non-slip flooring
- Factory-built to comply with the latest European Community Whole Vehicle Type Approval (WVTA) M2 minibus legislation with M1 standard rear seats



Power-operated side step

For easy passenger access, a power-operated side step extends automatically when the sliding door opens. When the door is closed, the step automatically retracts. (Standard)





More flexibility. More choice.

Transit Minibus provides the perfect mix of passenger carrying ability and load-carrying potential.



L2 H2 11/12 seats

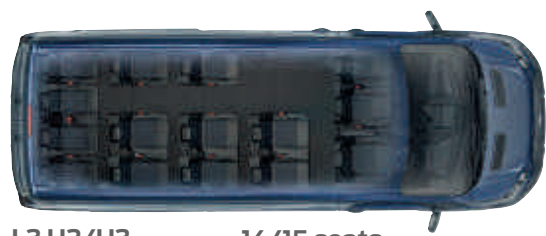

L3 H2/H3 14/15 seats



L4 H3 17/18 seats

A great place to be.

Transit Minibus Trend provides even greater comfort with height-adjustable head restraints, reclining seatbacks and armrests. For added versatility, selected rear seats can be removed to provide extra luggage space.

Smart storage.

With its light and spacious fully-trimmed interior, Transit Minibus has been designed to make even the longest journey a pleasure. New overhead storage shelves offer convenient stowage. Additional comfort is provided by optional rear air conditioning with aircraft-style vents and individual LED reading lights for each rear seat (Standard on Trend, option on Base).

Model shown is a Ford Transit Minibus 17 seat L4 H3 Trend.

Note Transit Minibus H3 (high roof) cannot be fitted with a roof rack.



Rear air conditioning

For a more comfortable travel experience, a separate air conditioning system is available for the rear passenger compartment, featuring its own rotary controls. (Standard on Trend, option on Base) Each row of seats is provided with two foot-level outlets for heating, with overhead air conditioning vents available for efficient air circulation (included with overhead storage shelves).

Room and comfort to spare.

Light, bright and easy to drive, Transit Minibus sets the standard for vehicles in its class. With exceptional levels of finish and refinement, smart driver-oriented technology, plus a range of practical and thoughtful features – like a fold-down table that’s integrated into the dual front passenger’s seat and large enough for a laptop computer – it’s the most comfortable and professional minibus on the road.



***Note: A rear-facing child seat should never be placed in the front passenger seat when the Ford vehicle is equipped with an operational front passenger's airbag. The safest place for children is properly restrained on the rear seat.**

Model shown is a Ford Transit Minibus Trend with radio/CD/SD-navigation system (option) and digital tachograph (option).

Use your voice like another pair of hands.

Ford SYNC lets you play music and make and receive hands-free calls – all with simple voice commands. With SYNC AppLink you can even control apps* on your smartphone using voice commands. And the Ford Emergency Assistance** feature is designed to assist occupants to place an emergency call and provide the emergency services with vehicle location information in their own language. (Standard)

*Compatible mobile phone required. You can browse a list of AppLink-compatible apps from your regional Ford website, or via the Ford App Catalog available in iOS and Android stores. **Ford Emergency Assistance is an innovative SYNC feature that uses a Bluetooth®-paired and connected mobile phone to help vehicle occupants initiate a direct call to the local Communications Centre, following a vehicle crash event involving an airbag deployment or fuel pump shut off. The feature operates in more than 40 European countries and regions. SYNC AppLink and Emergency Assistance are not supported by all European languages.



| SYNC

“Read message”

“Call Chris”

“Call office”



“Play album Greatest Hits”

“Call depot”

“Shuffle”

“What's playing?”

“Call home”





Built with safety in mind.

Safety is important to us, so the Transit Minibus does all that it can to help protect you, your passengers and those around you.



Driver Alert^{®2)}

Designed to warn you if the system detects driving behaviour that indicates a drop in alertness levels. Initially, a warning icon is displayed in the instrument cluster, followed by a warning chime if driving alertness further declines. (Standard)

Emergency Assistance**

Innovative SYNC feature that uses a Bluetooth[®]-paired and connected mobile phone to help vehicle occupants initiate a direct call to the local Communications Centre (in more than 40 European countries and regions), following a vehicle crash event involving an airbag deployment or fuel pump shut off. (Option, part of Ford SYNC)

****Compatible mobile phone required. Emergency Assistance is not supported by all European languages.**
Note The Bluetooth[®] word mark and logos are owned by the Bluetooth SIG, Inc. and any use of such marks by Ford Motor Company Limited and its associated companies is under licence. Other trademarks and trade names are those of their respective owners.

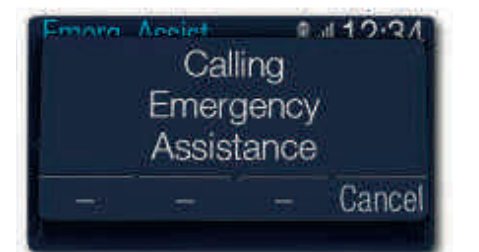

Side and curtain airbags^{®1)}

Designed to help protect the driver and front passenger's heads from injury. (Option)

Lane Keeping Alert^{®2)}

It only takes a momentary slip in concentration to drift out of your lane when driving on the highway. Lane Keeping Alert^{®2)} is designed to recognise when you approach the road markings without using the indicator, and alerts you with vibrations through the steering wheel. (Standard)

Electronic Stability Control (ESC)^{®3)}

ESC^{®3)} is designed to help you maintain control in extreme driving conditions. It senses when you are deviating from your chosen line and aims to keep you on track by automatically regulating braking and engine output. (Standard)

ISOFIX child seat fixing points

Second row seats incorporate ISOFIX child seat fixing points with top tether mounts for extra safety. (Standard)



[®]Uses sensors.
^{*}Operates at speeds over 40 mph on multi-lane roads with clearly visible lane markings.
¹⁾Safety feature.
²⁾Driver assistance feature.

Features
for more
comfortable
driving.



Rear air conditioning

For a more comfortable travel experience, a separate air conditioning system is available for the rear passenger compartment, featuring its own rotary controls. (Standard on Trend, option on Base). Each row of seats is provided with two foot-level outlets for heating and overhead air conditioning vents for efficient air circulation. Individual air vents are provided when combined with overhead storage shelves on H3 models. (Overhead shelves standard on L4 H3, optional on L3 H3)



Rear-view camera

Select reverse gear and the image from the rear-view camera is displayed automatically in the rear-view mirror or satellite navigation screen. Marker lines overlaid on the camera image indicate where the vehicle is heading. (Option)

Parking distance sensors, front and rear

An audible warning helps you judge the distance between your vehicle and obstacles at the front and rear for easier parking and manoeuvring. (Standard on Trend, Option on Base)

230 Volt power socket

A handy 230 Volt 150 Watt power socket, located between the driver's and passenger seats, can be used to charge laptops or other electrical equipment without the need for special adaptors. (Option)



Auto High Beam

When oncoming traffic is detected, the headlights are designed to dip automatically, then revert to high beam when the vehicle has passed. (Standard, as part of Lane-Keeping Alert)

Steering wheel with remote audio controls

Allows you to operate the audio system and trip computer without taking your hands off the wheel. (Standard)



Go further for less.

Transit Minibus's Duratorq TDCi diesel engines are among the most refined and efficient available. Featuring the latest common rail technology, they not only offer strong, dependable performance, but deliver excellent fuel consumption and low CO₂ emissions too.

Ford ECONetic Technology

Ford ECONetic Technology brings together a range of vehicle features and technologies to deliver optimal fuel economy, reduced emissions and lower cost-of-ownership, without compromising on performance or functionality.

Ford ECONetic Technologies include

- Ford Duratorq TDCi advanced diesel engines – providing optimal fuel economy and low CO₂ emissions
- Ford Auto-Start-Stop – switches off the engine when the vehicle is stationary
- Ford Smart Regenerative Charging – charges the battery only when needed
- Shift Indicator light – advises driver of optimum time to change gear
- Ford Eco Mode – encourages economical driving behaviour
- Acceleration Control – designed to prevent excessive acceleration when the vehicle is unladen (Option)
- Ford Battery Management System – improves battery life, fuel consumption and ensures ready-to-go reliability

Note The availability of Ford ECONetic Technology varies by model. Please ask your Ford Transit Specialist Dealer for details. For more information on our sustainability initiatives visit ford.com/go/sustainability

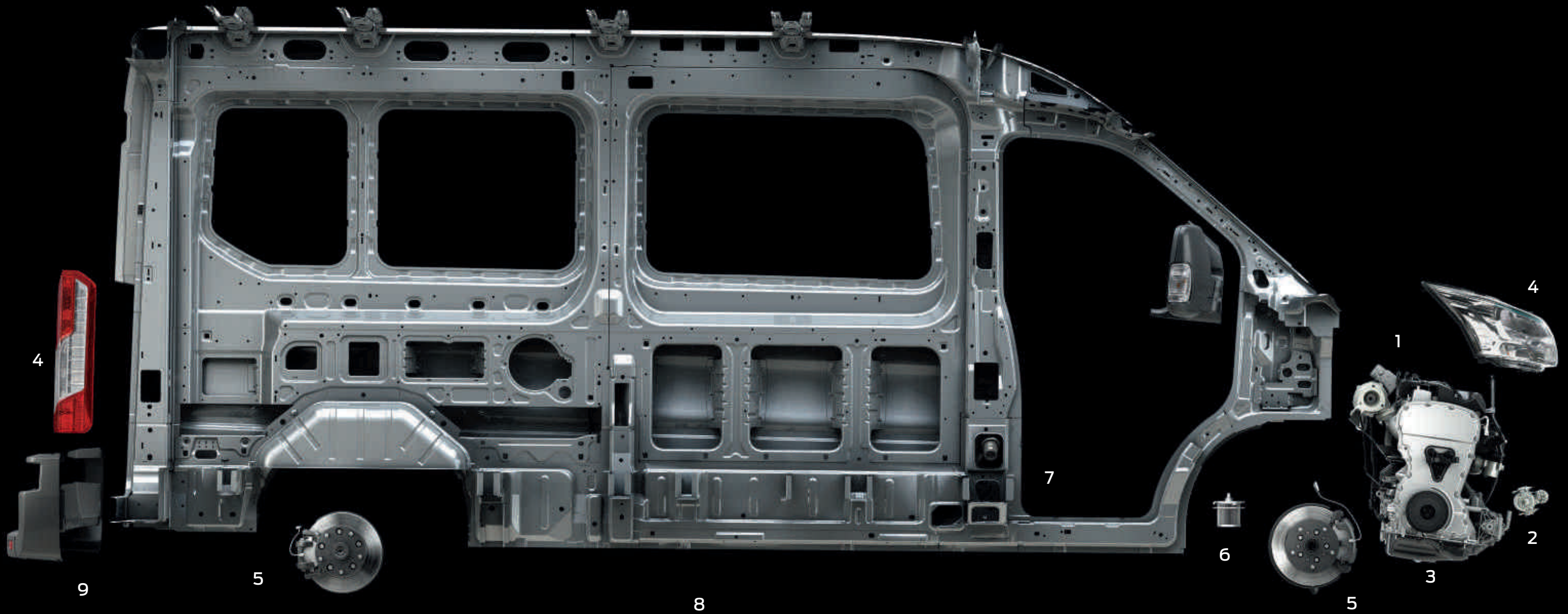

The sum of all parts adds up to less cost.

Quality and durability are built into the Transit Minibus at every step. After many years of service it will feel as good, and be as rewarding to drive, as the day you picked it up.

1. Extended service intervals of up to 30,000 miles (or two years) further reduce your running costs. (Standard)

2. Auto-Start-Stop automatically switches off the engine when you come to a halt and put the vehicle in neutral. Restarts smoothly when you want to move off, reducing fuel consumption and exhaust emissions. (Standard)

3. Engine oil monitor warning light will illuminate if the condition of the engine oil deteriorates between services. (Standard)

4. High-level light units are mounted above the bumper line, to help keep them out of harm's way and protect them from low speed accident damage. (Standard)

5. Brake pad wear sensors warn when the pads are due for renewal. (Standard)

6. Fuel filter sensor warns of water ingress or a blockage of the fuel system. (Standard)

7. Ford Easy-Fuel capless refuelling system – a unique safeguard ensures that nobody can accidentally fill up with the wrong fuel. Plus, no dirty fuel caps to touch. (Standard)

8. 12-year perforation warranty provides reassurance against perforation of the bodywork from the inside of the panel. (Standard)

9. Multi-piece rear bumper design helps to keep repair costs low. (Standard)

Keep your business on track.

Transit Minibus is fitted with our innovative Curve Control technology. The feature – part of Transit's standard Electronic Stability Control system – senses when a driver takes a curve too quickly and can rapidly reduce engine torque, and apply brakes to individual wheels, to help keep the vehicle safely under control.

Further ESC features include

- Curve Control
- Traction Control System
- Hill Start Assist
- Trailer Sway Control
- Load Adaptive Control (LAC)
- Emergency Brake Assist (EBA)
- Emergency Brake Warning
- Roll Stability Control (RSC)
- Torque Vectoring Control



Adaptive Cruise Control

Set your desired speed and Adaptive Cruise Control maintains a pre-set distance from the vehicle in front. If the sensors detect traffic slowing ahead, your vehicle automatically slows down. When traffic has cleared, your vehicle accelerates back to cruising speed. (Option on Trend)



Ford Easy-Fuel capless refuelling system
(Standard)



Base

Image above Ford Transit Minibus Base in Moondust Silver metallic body colour (option).

Exterior features

- Daytime running lights
- Door mirrors with large blind spot eliminator and integrated side indicators
- Integrated rear step
- Passenger's sliding side load door and power step
- Integrated rear step
- Half cap wheel covers (front wheels only on dual rear wheel models)
- Headlight courtesy delay
- Wide bodyside mouldings
- Rear mudflaps
- Euro VI emissions compliant
- Ford Easy-Fuel capless refuelling system
- Heated windscreen

Interior features

- High series instrument cluster with trip computer
- Ford SYNC radio/CD system with 3.5" dot matrix multi-functional display, Voice Control and AppLink (includes Emergency Assistance*), audio streaming, USB connectivity, steering wheel remote audio controls and four front speakers
- Leather-trimmed 4 spoke steering wheel
- Cruise control with Adjustable Speed Limiter
- Driver's 8-way seat adjust
- Passenger's 4-way seat adjust
- Rake- and reach-adjustable steering column
- Driver's and front passenger's♦ airbags
- Overhead storage shelves (H3 models only)
- Electrically-operated front windows
- Remote central locking
- Shift Indicator light
- Courtesy lights with theatre dimming
- Map-reading lights

- Easy-clean rubber floor covering
- Passenger side load door footwell illumination
- Lane Keeping alert
- Driver alert

Option Pack

- Low Visibility Pack (contents include electrically-operated/heated door mirrors and windscreen washer fluid low level sensor)

For further option availability, please refer to the specification section.

Engines

- 2.2 125 PS (HDT Euro 6)
- 2.2 155 PS (HDT Euro 6)

***Note: A rear-facing child seat should never be placed in the front passenger seat when the Ford vehicle is equipped with an operational front passenger's airbag.**

*Ford Emergency Assistance is an innovative SYNC feature that uses a Bluetooth®-paired and connected mobile phone to help vehicle occupants initiate a direct call to the local Communications Centre, following a vehicle crash event involving an airbag deployment or fuel pump shut off. The feature operates in more than 40 European countries and regions.





Rear air conditioning
(Standard)



Image above Ford Transit Minibus Trend in Lunar Sky body colour.

Trend

Exterior features additional to Base

- Front fog lights
- Projector-style halogen reflector lights with static cornering lights
- Titanium effect front grille (Ebony black front grille on models with Adaptive Cruise Control)
- Electrically-operated/heated door mirrors
- Full wheel covers (with single rear wheels)
- Rear privacy glass
- Front and Rear parking sensors

Interior features over Base specification

- Overhead storage shelves with individual air conditioning vents and LED lights (H3 models only)
- Leather-trimmed gear knob
- High visibility pack
- Cruise control with Adjustable Speed Limiter
- Front and rear manual air conditioning
- Reclining seats with armrests
- Lockable glovebox

Options

- Rear-view camera

For further option availability, please refer to the specification section.

Engines

- 2.2 125 PS (HDT Euro 6)
- 2.2 155 PS (HDT Euro 6)





Minibus
L2 (Medium wheelbase)
H2 (Medium roof)

11/12
seats



Minibus
L3 (Long wheelbase)
H2 (Medium roof)
and H3 (High roof)

14/15
seats

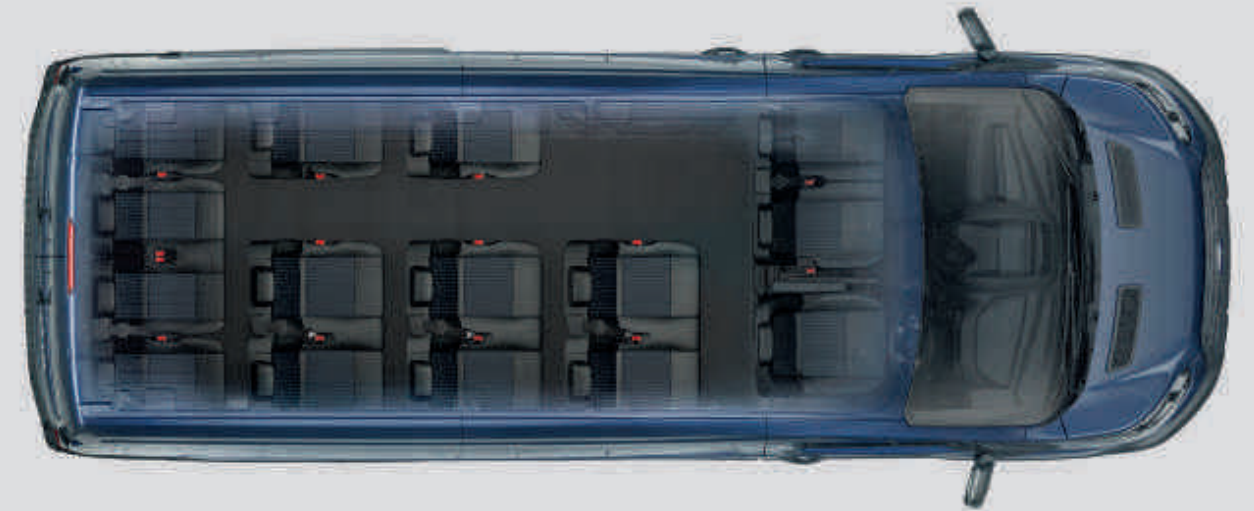

Minibus
L4 (Long wheelbase with
Extended Frame)
H3 (High roof)
Dual rear wheel (DRW)

17/18
seats

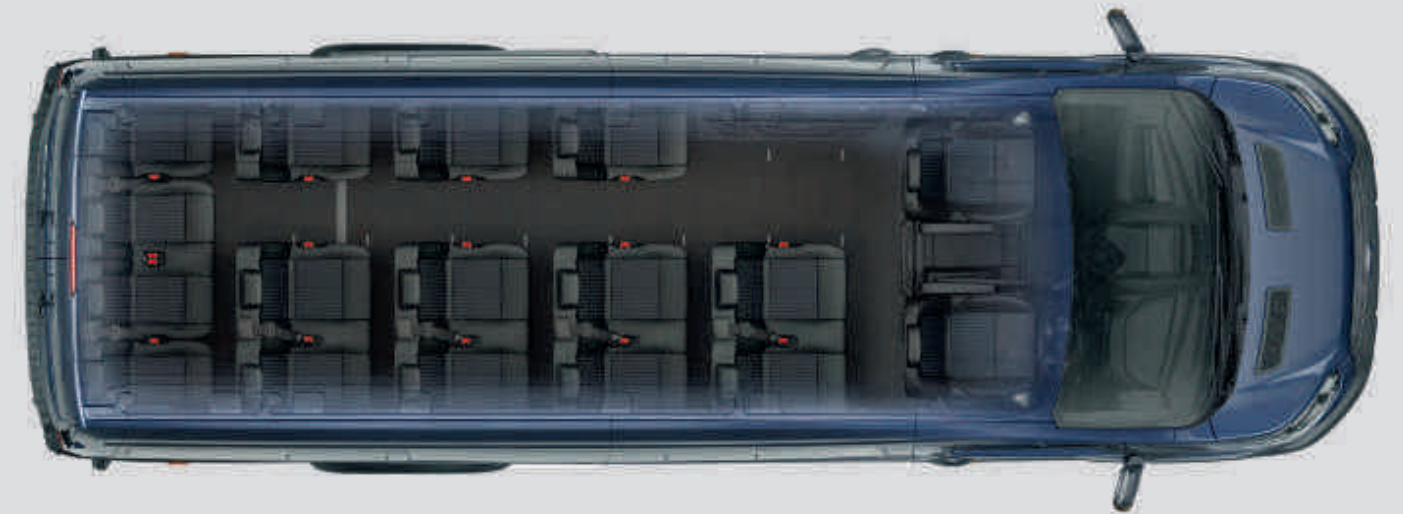

Transit Minibus.
Generous accommodation for up to eighteen people.

Transit Minibus provides safe and comfortable accommodation for up to eighteen people, including the driver. Available in a range of body lengths, driveline configurations and seating capacities - as well as options offering greater luggage space - it's the smartest choice for professional passenger transport.



Options and accessories.

Styling features, extra protection and greater versatility are all available for Ford Transit Minibus.

Part Name	Part Number (FINS)	Availability
Rear window protection grille	1838135	○ / A
Brink®+ tow bar, fixed	1855715	A
Brink®+ e-kit for tow bar, 13-pin connector	1855713	A
ClimAir®+ wind deflectors, front, light grey	1856560	A
ClimAir®+ wind deflectors, front, dark grey	1856561	A
Bosch®+ reverse warning device	1713304	A
Xvision®+ parking distance control, front	1804069	A
Xvision®+ parking distance control, rear	1804063	A
16" 5x2-spoke alloy wheel	1842987	○ / A
Locking wheel nuts, set of 4	1763879	○ / A
Premium safety pack	1872753	A

○ = Option, at extra cost. A = Accessory, at extra cost, +Please see back cover for warranty information.

ClimAir®+ wind deflectors
Reduce wind turbulence and noise, allowing you a more enjoyable drive with the windows down, even during light rain (Front wind deflectors available). (Accessory)

Bosch®+ reverse warning device
Linked to reverse gear. Provides an audible warning when the vehicle is reversing. (Accessory)



Rear window protection grille
Grille fixes to inside of rear windows for enhanced security without obscuring rearward vision. (Option and accessory)

16" alloy wheels
16" alloy 5x2-spoke alloy wheels. (Option)

Locking wheel nuts
Set of four locking wheel nuts to help protect wheels against theft. (Accessory)



Brink®+ tow bar
For extra transport capability, the fixed tow bar can tow up to 2,650 kg, depending on engine. (Accessory) (Commercial users may need a digital tachograph. A fitting kit is available from your Ford Dealer)

✦ Item covered by third party supplier's warranty, please see back cover for details.



Premium Safety Pack
Be prepared with the Premium Safety Pack containing DIN-compliant Ford safety equipment – warning triangle, high-visibility vest, first aid kit and gloves. (Accessory)



Xvision® parking distance control
Enables easier parking and manoeuvring in tight spaces through its acoustic warning. (Accessory)

For more accessories for your Ford Transit visit www.ford-accessories.co.uk
For a range of Ford branded items – from clothing to lifestyle products and model cars – visit www.fordlifestylecollection.com

Electronic Stability Control⁽¹⁾

Transit Minibus is fitted with Electronic Stability Control (ESC)⁽¹⁾ as standard. The advanced system constantly monitors the path the vehicle is following and compares it to the driver's intended course. If ESC senses a significant difference, it automatically reduces engine torque and applies brakes to individual wheels to help stabilise the vehicle and keep it safely on track.

Curve Control⁽¹⁾

Senses when a driver takes a curve too quickly, and can rapidly reduce engine torque – and apply brakes to individual wheels – to help keep the vehicle safely under control. (Standard)

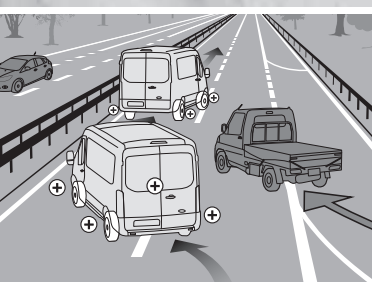

Roll Stability Control⁽¹⁾

Ford's unique roll-rate sensor helps the Roll Stability Control system to keep the tyres grounded under conditions of high centre of gravity and when driving through negative camber turns. (Standard)

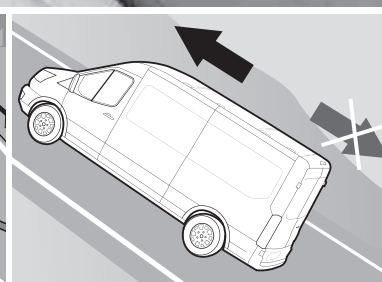

Hill Start Assist⁽²⁾

Designed to temporarily prevent you from rolling down a slope when you move your foot from the brake pedal to the accelerator pedal. It works in forward and reverse gears, so is ideal for towing and pulling heavy loads. (Standard)

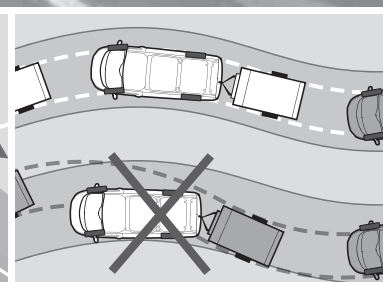

Trailer Sway Control⁽¹⁾

When it detects trailer sway, the system is designed to reduce engine torque and apply the brakes to the appropriate wheel(s) to help maintain control – standard with Ford tow bar.

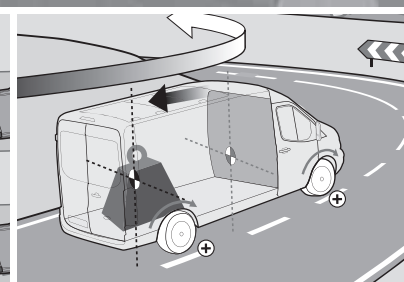

Load Adaptive Control⁽¹⁾

Designed to adjust the responses of the ESC⁽¹⁾ system to compensate when the vehicle is unladen, partially- or fully-laden. (Standard)

Exterior features

	Base	Trend
Design features		
Roof Height – H2 (Medium Roof; not available on L4 17/18-seat)	●	●
Roof Height – H3 (High Roof; not available on L2 11/12 seat, standard on L4 17/18 seat) includes rear passenger overhead shelves	○/●	○/●
Door Handles – Self Colour	●	●
Door mirrors – Blind spot eliminator and integrated side indicator	●	●
Door mirrors – Manual	●	-
Door mirrors – Electrically-operated and heated	○	-
Door mirrors – Power-foldable, electrically-operated and heated	○	●
Bodyside mouldings – Wide, self colour	●	●
Front bumper – Self colour	●	●
Rear bumper – Self colour with integrated step	●	●
Front grille – Sterling Grey	●	-
Front grille – Studio Grey	-	●
Mudflaps – Front	○	○
Mudflaps – Rear	●	●
Glass – Tinted complete (71% luminous transmittance)	●	○
Glass – Rear privacy (33% luminous transmittance)	○	●
Tow bar with Trailer Sway Control and 13-pin electrics (tachograph may be required)	○	○
Paint – Metallic	○	○+
Wheels		
Steel – 16"x6½ wheels (Fitted with 235/65 R16 tyres; L2 and L3 only)	●	●
Steel – 16"x6½ wheels, dual rear wheels, wheel covers on front wheels (Fitted with 195/75 R16 tyres; L4 only)	●	●
Alloy – 16"x6½ 5-spoke wheels with locking wheel nuts (Fitted with 235/65 R16C tyres) (not available on L4)	-	○
Wheel covers – Half caps (excludes dual rear wheels)	●	-
Wheel covers – Full (excludes dual rear wheels)	-	●
Spare – Full-size steel with tool kit (standard with dual rear wheels)	○	○
Tyre inflator kit (in lieu of spare wheel. Not available with dual rear wheels)	●	●

● = Standard, ○ = Option, at extra cost, ○+ = No Charge Option, □ = Part of an option pack, at extra cost.
L2 = MWB 11/12-seat, **L3** = LWB 14/15-seat, **L4** = ELWB 17/18-seat.

Engine undershield

Tough corrosion-resistant metal undershield protects engine from accidental stone and kerb damage. Easily removed for oil changes and routine servicing. (Accessory)

Driving with AdBlue[®]

To operate correctly, the AdBlue[®] tank of your Ford Transit Minibus with Ford Duratorq (HDT Euro 6) diesel engine must be filled with AdBlue[®] fluid. System warnings illuminate when the fluid level becomes too low. For more information, please discuss with your Ford Dealer.

Never misfuel again

Ford Easy-Fuel capless refuelling system

A unique safeguard ensures nobody can accidentally fill up with the wrong fuel. Plus no dirty fuel caps to touch. (Standard)

⁽¹⁾Uses sensors.
⁽²⁾Operates at speeds over 40mph on multi-lane roads with clearly visible lane markings.
⁽¹⁾Safety feature.
⁽²⁾Driver assistance feature.

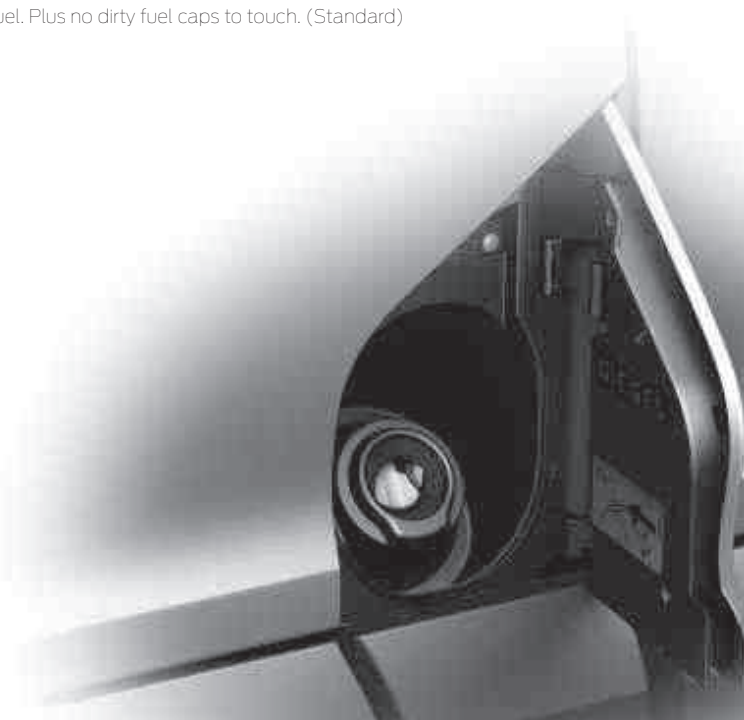

Exterior features

	Base	Trend
Convenience features		
Headlights – Projector style halogen reflector lights with chrome background, static cornering lights	-	●
Headlights – Daytime running lights	●	●
Headlights – Courtesy delay, 30 second duration	●	●
Heated windscreen	●	●
Fog lights – Front	○	●
Doors – Glazed passenger's sliding side load door (fitted with Emergency Release Hammer)	●	●
Power Step – Passenger's side load door	●	●
Doors – Glazed rear doors, hinged for 180° opening, positive stop at 90°	●	●
Doors – Glazed rear doors, hinged for widest opening, up to magnetic door retainers (not available on L2 models, optional on L3 and standard on L4)	○	○
Roof escape hatch	●	●
Windows – Rear, heated	●	●
Windows – Second row, fixed	○	○
Windows – Second row, driver's side slide-opening	●	●
Windows – Second row, kerbside slide-opening	○	○
Windows – Third row, fixed	●	●
Windows – Fourth row, fixed (Standard on L3; not available on L2 and L4)	●	●
Windows – Fourth row, flip opening (Standard on L4; not available on L2 and L3)	●	●
Wipers – Front, variable interval/intermittent with electrically-operated wash	●	●
Wipers – Rear with auto reverse wipe and electrically-operated wash (not available with wide opening rear doors)	●	●
Parking distance sensors – Front and rear (requires front fog lights)	○	●

● = Standard, ○ = Option, at extra cost, ○+ = No Charge Option, □ = Part of an option pack, at extra cost.
L2 = MWB 11/12-seat, **L3** = LWB 14/15-seat, **L4** = ELWB 17/18-seat.

Option packs

	Base	Trend
Option packs		
Low Visibility Pack – Washer fluid sensor, electrically-operated and heated door mirrors	○	-

● = Standard, ○ = Option, at extra cost, ○+ = No Charge Option, □ = Part of an option pack, at extra cost.
L2 = MWB 11/12-seat, **L3** = LWB 14/15-seat, **L4** = ELWB 17/18-seat.

Unrivalled passenger transport



Power-foldable door mirrors

Electrically-operated and heated with large spotter lens. Perfect for parking in tight spaces or squeezing through narrow lanes. (Standard on Trend)

Headlights and front fog lights

Trend series is equipped with projector-style signature headlights, featuring a chrome background and cornering light. Front fog lights further enhance Transit's lighting performance. (Standard on Trend)

Emergency exits (including roof escape hatch)

Transit Minibus meets Annex 7 of ECE R 107 and has the applicable minimum number of 4 emergency exits - 1 x Double service side load door, 2 x emergency break glass windows, and a roof escape hatch. (Standard)



Quickclear heated windscreen

Clears ice or demists the windscreen quickly, even on frosty mornings. Supplied with heated washer jets for year-round comfort and visibility. (Standard)



Interior features

	Base	Trend
Design features		
Floor covering – Complete, easy-clean and rubber insulated	●	●
Headlining – Complete (covers full length of vehicle)	●	●
Steering wheel – 4-spoke, leather-trimmed	□	●
Interior lighting		
Courtesy lights – Front and rear lights and map-reading lights with theatre-style dimming	●	●
Courtesy lights – Footwell illumination (side load door only)	●	●
Interior lighting/battery saver – 30 minutes	●	●
Passenger compartment lights	●	●
Audio and communication systems		
Radio/CD, 3.5" dot matrix display, extended integrated control panel, Ford SYNC – including Emergency Assistance*, AppLink®, Bluetooth® with Voice Control System and audible text messaging, USB and Privacy Mode, USB connectivity port with iPod® functionality, remote audio controls, four front speakers (two woofers and two tweeters) ICE Pack 4	●	●
Radio/CD with DAB, 3.5" dot matrix display, extended integrated control panel, Ford SYNC – including Emergency Assistance*, AppLink®, Bluetooth® with Voice Control System and audible text messaging, USB and Privacy Mode, USB connectivity port with iPod® functionality, remote audio controls, four front speakers (two woofers and two tweeters) ICE Pack 5	○	○
Radio/CD/SD-navigation system with DAB, SYNC (includes Emergency Assistance*) with Bluetooth®, Voice Control System, AppLink®, audible text messaging and privacy mode, 5" TFT display, extended integrated control panel, USB connectivity port with iPod® functionality, remote audio controls, four front speakers (two woofers and two tweeters) ICE Pack 11	○	○
Radio/CD/SD-navigation system with DAB with rear view camera, SYNC (includes Emergency Assistance*) with Bluetooth®, Voice Control System, AppLink®, audible text messaging and privacy mode, 5" TFT display, extended integrated control panel, USB connectivity port with iPod® functionality, remote audio controls, four front speakers (two woofers and two tweeters) ICE Pack 40	○	○
Instruments and controls		
Trip computer (distance to empty, instant and average fuel consumption, average speed, outside temperature)	●	●
Water in fuel filter sensor	●	●
Battery – Cold start (-20°C)	●	●
Battery – Twin improved flooded (IF) 80Ah, 700 CCA	●	●
Battery – Cold start (-29°C)	○	○
Alternator – Standard duty (150 Amp)	●	●
Alternator – Heavy duty (220 Amp) (with 230V Power adaptor)	-	□
Tachograph – Digital, electronic, 24-hour	○	○
Shift Indicator light	●	●

● = Standard, ○ = Option, at extra cost, □ = Part of an option pack, at extra cost.

L2 = MWB 11/12-seat, L3 = LWB 14/15-seat, L4 = ELWB 17/18-seat.

Note: The Bluetooth® word mark and logos are owned by the Bluetooth SIG, Inc. and any use of such marks by Ford Motor Company Limited and its associated companies is under licence. Other trademarks and trade names are those of their respective owners.

*Ford Emergency Assistance is an innovative SYNC feature that uses a Bluetooth®-paired and connected mobile phone to help vehicle occupants initiate a direct call to the local Communications Centre, following a vehicle crash event involving an airbag deployment or fuel pump shut off. The feature operates in more than 40 European countries and regions.

Control at your fingertips



Steering wheel-mounted controls

Allows you to operate the audio system and trip computer without taking your hands off the steering wheel. (Standard)

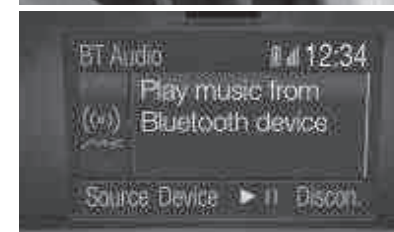

Bluetooth® Audio Streamings

Stream your music collection from your compatible MP3 player or mobile phone to the vehicle's audio system. (Standard)



Navigation

3D map stored on SD card shows points of interest on a 5" colour screen. Also includes traffic announcements. (Option)



Complete connectivity

Ford SYNC with AppLink* lets you operate most popular MP3 players, Bluetooth®-enabled phones, USB drives and even control the apps on your smartphone with remarkably simple voice commands. Plus, the Emergency Assistance* feature is designed to assist occupants to place an emergency call in the event of an accident in over 40 European countries and regions. (Standard)



Emergency Assistance*

Innovative SYNC feature that uses a Bluetooth®-paired and connected mobile phone to help vehicle occupants initiate a direct call to the local Communications Centre (in more than 40 European countries and regions), following a vehicle crash event involving an airbag deployment or fuel pump shut off. (Option, part of Ford SYNC)

Audible SMS

Have your incoming text messages read to you from your connected phone, including commonly-used abbreviations and emoticons, and you can even respond with a choice of 15 preset text messages. Compatible mobile phone required.



*Compatible and connected mobile phone required. You can browse a list of AppLink-compatible apps from your regional Ford website, or via the **App Catalog** available in iOS and Android stores. SYNC AppLink and Emergency Assistance are not supported by all European languages.

Note: The Bluetooth® word mark and logos are owned by the Bluetooth SIG, Inc. and any use of such marks by Ford Motor Company Limited and its associated companies is under licence. Other trademarks and trade names are those of their respective owners.

Interior features

	Base	Trend
Seats		
Driver's seat – 8-way (fore/aft; recline; height; and tilt) with armrest (and lumbar, at Trend)	●	●
Driver's seat – 10-way (fore/aft; recline; height; tilt; and lumbar) with armrest	○	●
Driver's seat – 10-way power, heated (fore/aft; recline; height; tilt; and lumbar) with armrest	-	○
Front passenger's seat – Single, 8-way (fore/aft; height, tilt, and recline)	●	●
Front passenger's seat – Single, 8-way heated (fore/aft; recline; height; and tilt)	○	○
Front passenger's seat – Dual, fixed back with lift-up seat cushion for stowage, fold out table	●	●
Front passenger's seat – Dual, heated, fixed back with lift-up seat cushion for stowage, fold out table	○	○
Rear seats – M1 Standard – adjustable headrest design	●	●
Rear seats – Nine seat positions (standard on L2, optional on L3)	●/○	●/○
Rear seats – Twelve seat positions (standard on L3)	●	●
Rear seats – Fifteen seat positions (L4 460 only)	●	●
Rear seats recline with fixed armrests (not available on last row quad seating)	-	●
Comfort and convenience		
Air conditioning – Front, filter-air pollen purifier	○	○
Air conditioning – Rear, ducted through individual passenger vents from overhead shelves on H3 (includes front air conditioning)	○	●
Heater – PTC (Positive Temperature Coefficient, provides additional heat during warmup)	●	●
Assist handle – Located on passenger A-Pillar	●	●
Assist handle – Located on B-Pillar	●	●
Bottle holder – Twin, 2-litre bottle capacity, fascia-mounted	●	●
Driver's sunglasses holder	-	●
Glovebox – With lid and A4 file storage capability	●	-
Glovebox – With lockable lid and A4 file storage capability	-	●
Power point socket – 2 x 12 V (located on instrument panel and in stowage bin)	●	●
Power point socket – 12 V (located in rear)	○	○
Power point – 230 V (150 Watt) power converter	○	○
Overhead console – Front (includes 2 DIN)	●	●
Rear-view camera in rear-view mirror (including Trailer Hitch Assist) (image is displayed in the rear view mirror or in TFT)	○	○
Smokers' Pack – Cigar lighter and ash cups (front)	○	○
Rear overhead shelving (H3 only)	○	○
Rear overhead shelving with individual air conditioning vents and LED lights (H3 only)	○	●
Rear coat hooks	●	●
Storage – Front door map pockets	●	●
Storage – Driver's side, storage compartment on fascia top with lift-up lid	●	●
Windows – Front, electrically-operated (driver's side – one shot up/down)	●	●
Rear window protection grille	○	○

● = Standard, ○ = Option, at extra cost, □ = Part of an option pack, at extra cost.
L2 = MWB 11/12-seat, **L3** = LWB 14/15-seat, **L4** = ELWB 17/18-seat.

Lidded storage compartment with power point and USB port

Cleverly concealed storage compartment, located above the instrument cluster, features a 12-volt power supply and USB port. (Standard with Ford audio systems)



First-class comfort in every seat

Reclining seat backs and armrests*, plus the ability to remove rear seats to accommodate wheelchairs or provide extra luggage space, means Transit Minibus opens up a range of new possibilities. Inertia-reel seat belts are fitted to every seat, along with padded head restraints for comfort and security.



A place for everything

Transit Minibus's driver-focused cab combines modern good looks with smart stowage solutions. With plenty of space for bottles, phones and papers, it will help make your workday easier and more efficient.

Adjustable driver's seat and steering wheel

An adjustable driver's seat with armrest and a steering wheel that adjusts to suit your height and arm length mean you can find your ideal driving position with ease. (Standard)



Electrically-operated driver's seat

A 10-way electrically-adjustable heated driver's seat with lumbar support is an ideal choice for vehicles with multiple drivers. (Option on Trend)



Safety and security features

	Base	Trend
Safety and driver assistance		
Anti-lock braking system (ABS) with Electronic brake-force distribution ¹	●	●
Electronic Stability Control (ESC) ¹⁾	●	●
Curve Control ¹⁾	●	●
Hill Start Assist (HSA) ²⁾	●	●
Load Adaptive Control (LAC) ¹⁾	●	●
Emergency Brake Assist (EBA) ¹⁾	●	●
Emergency Brake Warning (automatic activation of hazard warning lights under heavy braking) ²⁾	●	●
Roll Stability Control ¹⁾	●	●
Trailer Sway Control (TSC) activated with Ford trailer tow attachments ¹⁾	○	○
Airbag – Driver's ¹⁾	●	●
Airbag – Front passenger's* with deactivation switch ¹⁾	●	●
Airbag – Front side and curtain airbags ¹⁾	○	○
Lane-Keeping Alert (includes Driver Alert ²⁾ and Auto High Beam ¹⁾ , high series instrument cluster, cruise control, leather-trimmed steering wheel, Quickclear heated windscreen and SYNC audio system)	●	●
Cruise control (including leather-trimmed steering wheel and Adjustable Speed Limiter)	●	●
Adaptive Cruise Control with Forward Alert (includes unique Ebony Black front grille and front and rear parking distance sensors)	-	○
Seat belts – 3-point diagonal inertia reel (all seats) ¹⁾	●	●
Tyre Pressure Monitoring System (TPMS) (not available with DRW) ¹⁾	○	○
Emergency Release Hammer	●	●
First Aid Kit	○	-
Fire Extinguisher 2L	●	●
Security		
Alarm – Perimeter	○	○
Immobiliser – Safeguard Passive Anti-Theft System (PATS) (Insurance-approved Category 2 immobiliser)	●	●
Locks – Power central locking	●	●
Locks – Remote control central locking with 1 key fob	●	-
Locks – Remote control central locking with 2 key fobs	○	●
Locks – Additional manual fleet key	○	-
Locks – Auto relocking, doors relock after 45 seconds if no door is opened	●	●
Locks – Key-operated bonnet release	●	●
Standard Key	●	●
Vehicle Identification Number – Visible	●	●

● = Standard, ○ = Option, at extra cost.

*Note: A rear-facing child seat should never be placed in the front passenger seat when the Ford vehicle is equipped with an operational front passenger's airbag.

¹⁾Safety feature, ²⁾Driver assistance feature.

Keeping you informed



Tyre Pressure Monitoring System

Allows you to monitor tyre pressure while on the move. System alerts you if it detects that a tyre's pressure is too low, such as in the case of a puncture. (Option, not available with DRW)

All-weather floor mats

Equipped with the Transit nameplate. All-weather floor mats are tailor-made to fit your Ford perfectly and help to protect against dirt and damp. When securely fixed directly onto the vehicle's floor, the driver's mat is designed to not slip and interfere with the pedals. (Accessory)



Mechanical features

	Base	Trend
Engine Technology		
Auto-Start-Stop system	●	●
Ford Eco Mode driver information system	●	●
Acceleration Control	○	○
Coated diesel particulate filter (DPF)	●	●
Brakes		
Dual-circuit front and rear discs, with self-adjusting servo-assistance and ABS	●	●
Fuel tank		
Standard- 80 litres	●	●
Ford Easy-Fuel capless refuelling system with misfuel inhibit	●	●
Ford Easy-Fuel capless refuelling system without misfuel inhibit	○	○
Urea aftertreatment system – 21 litre (standard with Stage VI HDT, not available on other engines)	●	●
Steering		
Power-assisted steering (PAS)	●	●
Steering column – Rake- and reach-adjustable	●	●
Suspension		
Front, independent MacPherson struts, coil springs, stabiliser bar, rear leaf springs and gas-pressurised shock absorbers	●	●
Engine governors		
Speed Limiter – 62 mph	●	●

● = Standard, ○ = Option, at extra cost.

Special Vehicle Options

	SVO Code	Base	Trend
Electrical			
Auxiliary fuse panel	A526	○	○
Paint			
Special Paint, 100 solid colours available, consult Dealer for details*	Various	○	○

○ = Option, at extra cost.

*SVO paint suffix must be entered at time of ordering. SVO paint pulls self-colour (black) bumpers, bodyside mouldings, mirror housings and door handles.

11.9m turning circle*

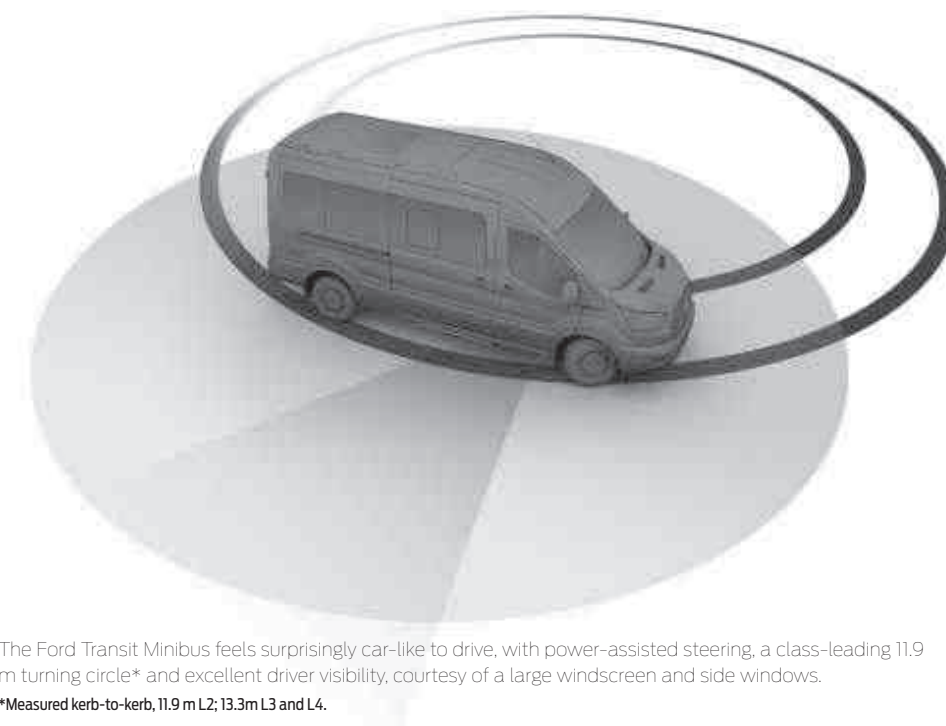

The Ford Transit Minibus feels surprisingly car-like to drive, with power-assisted steering, a class-leading 11.9 m turning circle* and excellent driver visibility, courtesy of a large windscreen and side windows.

*Measured kerb-to-kerb, 11.9 m L2; 13.3m L3 and L4.

Dimensions

	L2 H2 (SRW) 11/12-Seat RWD	L3 H2 (SRW) 14/15-Seat RWD	L3 H3 (SRW) 14/15-Seat RWD	L4 H3 (DRW) 17/18-Seat RWD
A Overall length	5531	5981	5981	6704
B Overall width (with/without mirrors)	2474/2059	2474/2059	2474/2059	2474/2126
C Overall height*	2410-2489	2449-2517	2688-2756	2502-2674
D Wheelbase	3300	3750	3750	3750
E Front of vehicle to front wheel centre	1023	1023	1023	1023
F Rear of vehicle to rear wheel centre	1208	1208	1208	1931
G Side door entry width	1200	1200	1200	1200
H Side door entry height	1564	1564	1564	1564
I Rear door entry width	1520	1520	1520	1520
J Rear door entry height	1597	1597	1836	1836
Internal height	1718	1718	1955	1955
K Space between wheel arches (SRW/DRW)	1364/-	1364/-	1364/-	-/1140
L Luggage space length at floor/top of seat (with delete 5th row seat option)	-	887/1156	887/1156	-
M Luggage space width at floor	-	1749	1749	-
Turning circle (m)				
Kerb to kerb with 16" wheels	11.9	13.3	13.3	13.3

L2 = Medium wheelbase, **L3** = Long wheelbase, **L4** = Long wheelbase extended length, **H2** = Medium Roof, **H3** = High Roof, **RWD** = Rear wheel drive, **SRW** = Single Rear Wheel, **DRW** = Dual Rear Wheel. All dimensions are subject to manufacturing tolerances and refer to minimum specification models and do not include additional equipment. These illustrations are for guidance only. *Height dimensions show the range from minimum to maximum of a fully laden, lowest payload vehicle to unladen highest payload vehicle.

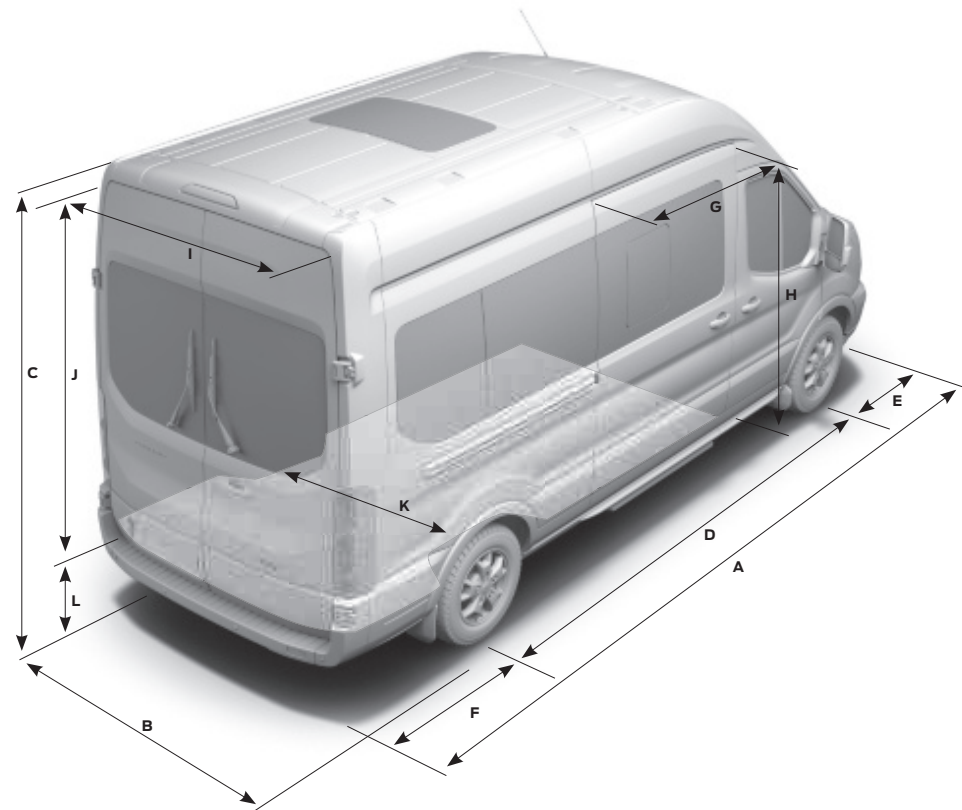

Weights, loads and performance

The fuel economy figures quoted in the table below are achieved by following strict EU governed test procedures and are specifically designed to enable customers to compare vehicles from all manufacturers on a like-for-like basis. Fuel consumption is directly affected by the length of the journey; number of passengers and amount of luggage carried; individual driving style; road and traffic conditions; weather conditions; vehicle age, mileage, condition and standard of maintenance; use of vehicle features such as air conditioning; and any modifications to the vehicle such as the addition of a roof rack. Your fuel economy will vary based on these and other factors and, for these reasons, many drivers may not achieve the EU fuel economy figures (below) in day-to-day driving, although the vehicle is technically capable of doing so.

	Gross payload ^g	Gross vehicle mass (kg)	Kerb mass (kg)*	Front axle plated mass (kg)	Front axle kerb mass (kg)	Rear axle plated mass (kg)	Rear axle kerb mass (kg)	Axle ratio	Max. GTM (kg)	Max trailer weight braked (unbraked)	CO ₂ emissions (g/km) ⁹⁰	Fuel consumption in mpg (L/100 km) ⁹⁰		
											Urban	Extra Urban	Combined	
350 L2 Minibus (11/12 seats)														
2.2 Duratorq TDCi 125PS/155PS Stage VI HDT	854	3500	2646	1750	1349	2100	1297	3.31	3500	n/a	196	31.4 (9.0)	43.5 (6.5)	38.2 (7.4)
410 L3 Minibus (14/15 seats)														
2.2 Duratorq TDCi 125PS/155PS Stage VI HDT	1302	4100	2798	1850	1419	2500	1379	3.31	5500	2450 (750)	196	31.4 (9.0)	43.5 (6.5)	38.2 (7.4)
460 L4 Minibus (17/18 seats)														
2.2 Duratorq TDCi 125PS/155PS Stage VI HDT	1328	4600	3272	1850	1330	3120	1942	3.31	5350	1800(750)	196	31.4 (9.0)	43.5 (6.5)	38.2 (7.4)

L2 = Medium wheelbase, **L3** = Long wheelbase, **L4** = Long wheelbase extended length, **H2** = Medium roof, **H3** = High roof, **SRW** = Single rear wheels, **DRW** = Dual rear wheels. *Kerb mass is affected by many factors such as bodystyles, engines and options. It is the weight of a standard-specification base vehicle (different series will have different kerb masses), including fluids and fuel tank 90% full, but without the driver (75kg), crew or cargo. Payload within this guide is the difference between gross vehicle mass (GVM) and kerb mass with a further 75kg deduction for the weight of the driver. It must be noted that actual weight will always be subject to manufacturing tolerances which may result in payload variations between this guide and actual weight. For customers intending to load vehicle close to maximum payload, we suggest you also add a margin for error of 5% of Kerb Mass to the Kerb Mass figure before calculation, to reduce risk of overloading. NB: It is the responsibility of the vehicle operator to ensure their vehicles are legally compliant for road use. A guide on fuel economy and CO₂ emissions which contains data for all new passenger vehicle models is available at any point of sale free of charge or can be downloaded under <http://carfueldata.dft.gov.uk/>.

Model availability

	350 L2 H2 Minibus	410 L3 H2 Minibus	410 L3 H3 Minibus	460 L4 H3 Minibus
RWD				
2.2 Duratorq TDCi 125 PS (92 kW) Stage VI HDT	●	●	●	●
2.2 Duratorq TDCi 155 PS (114 kW) Stage VI HDT	●	●	●	●

● = Available. **L2** = Medium wheelbase, **L3** = Long wheelbase, **L4** = Long wheelbase extended length. **H2** = Medium Roof, **H3** = High Roof. **RWD** = Rear wheel drive.

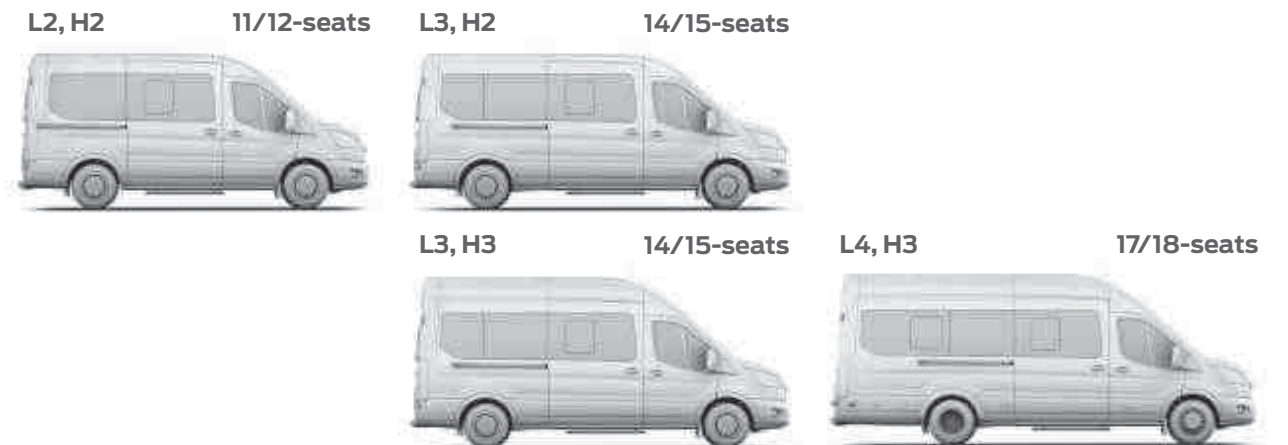

Making life easy

Our range of finance, service and assistance options is designed with just one thing in mind – making life easy for you.

Ford Transit24

At Ford we recognise the importance of minimising downtime, inconvenience and expense – that’s why we provide first-class aftersales support.

When it comes to the service, maintenance and repair of your Ford commercial vehicles, look no further than your nearest Transit Centre. Dedicated to looking after your vehicle, Transit Centres offer specialised workshop equipment, tools and training, and can look after all your service, maintenance and warranty work.

Convenient servicing

While-you-wait servicing Your commercial vehicle can be serviced when it suits you. Late night service appointments are available at least once a week and we respond to link online service booking requests within twenty minutes.

Collection and delivery This can be arranged at the time of your service booking for locations within a reasonable travelling time. So that it looks its best, your vehicle will be washed.

Fleet National Pricing Maximum recommended pricing for fleets with over 25 vehicles ensures you get the best price for routine services and fixed-content job.

MOTs and more Transit Centres can handle MOTs (including Class 5 and 7 tests), tachograph servicing and speed limiting (VOSA approved).

Other benefits

Ford parts availability Ford will endeavour to ensure any parts required will either be in stock or delivered anywhere on the UK mainland by 9am the next working day.

Genuine Ford parts quality All parts are designed and engineered by Ford, to Ford standards. Parts fitted to a vehicle outside of warranty carry a ‘fitted in service’ parts warranty.

Ford diagnostics For speedy and accurate fault diagnosis, we provide a sophisticated, internet-linked vehicle diagnostics system.

Ford trained technicians Ford commercial vehicle dealers have Ford-trained technicians, supported by online technical information and a Ford technical hotline.

Unscheduled repairs When your commercial vehicles aren’t working, neither are your drivers. Our priority is to get your vehicle back on the road as quickly and as efficiently as possible.

Priority treatment for urgent repairs Initial diagnosis on urgent (vehicle off-road) repairs is carried out on arrival, with parts ordered within two hours of arrival – especially helpful when a replacement vehicle won’t do. We aim to complete most repairs the same working day.

Dedicated backup from Ford

Ford Fleet Electronic Recall Programme This simplifies the process of recalls and improves communications with the operators of affected vehicles.

Ford Fleet Service Centre A dedicated team of experienced service advisors to assist with your aftersales issues.

Ford Fleet Accident Management Whatever the make of the vehicle, we offer a free, ethical and comprehensive accident management programme.

Efficiency, accuracy and convenience are at the heart of the Ford Transit24 commercial vehicle service promise. So, whether it’s servicing, maintenance or repair you need, be sure to come and see us.

For more information and to find your nearest Transit Service Dealer, visit the aftersales support section at www.ford.co.uk/fordfleet

Commercial Vehicle Finance

When it comes to financing your Ford Commercial Vehicle, our size and expertise means we’re well placed to provide you with a wide range of finance products.

Ford Credit*: Provides a range of finance plans for Commercial Vehicle customers interested in owning their vehicle.

Ford Lease*: Specialises in contract hire and leasing and provides an alternative range of finance plans which can be tailored to suit your business. Business users only.

Important Information:

*Ford Credit: Finance subject to status. Guarantees may be required. Freeport Ford Credit.

Ford Credit is a trading style of FCE Bank plc, which is authorised by the Prudential Regulation Authority and regulated by the Financial Conduct Authority and Prudential Regulation Authority under firm reference number 204469.

*Ford Lease: Ford Lease is provided by ALD Automotive Ltd, trading as Ford Lease. BS16 3JA. ALD Automotive is registered in England No. 987418. For the purposes of the Data Protection Act 1998 the data controllers in relation to any information you supply are Ford Motor Company Limited, FCE Bank Plc and ALD Automotive. Finance subject to status. Guarantees and indemnities may be required. ALD Automotive is authorised and regulated by the Financial Conduct Authority in respect of general insurance products. Ford Lease is a registered trademark of Ford Motor Company Limited.

Services

To find the location of your nearest Transit Centre simply visit the Ford Dealer locator at www.fordvans.co.uk

Ford Warranty Every new Ford Fiesta Van and Ford Ranger is protected by a 3-year/ 60,000 mile* warranty*.

Ford Transit, Transit/Tourneo Custom, Transit/Tourneo Connect and Transit Courier are protected by a 3-year/100,000 mile warranty*.

Ford Transit Chassis Cab One-Stop bodywork is covered by a 3-year/ 100,000 mile warranty* and a 3-year Perforation Warranty provided by the bodywork supplier.

Ford Perforation Warranty Ford Ranger, Transit, Transit/Tourneo Custom, Transit/Tourneo Connect, Transit Courier and Fiesta Van are covered by the Ford Perforation Warranty* for 12 years from the date of first registration. Please see your Ford Transit Specialist Dealer for details.

Ford Assistance Ford Transit, Transit Custom, Transit Connect and Ranger are supplied with a minimum of a 1-year Ford Assistance roadside package. Further details are available either on www.ford.co.uk or from your local Ford Dealer.

Ford Accident Repair Centres Approved Ford Accident Repair Centres meet rigorous Ford standards and are the best place to return your vehicle to its pre-accident condition.

Contacts

Ford Customer Relationship Centre In the unlikely event that your Ford Dealer can’t help you or if you need to speak to us directly, call 0203 564 4444 at local rates.

Ford Rental – local service nationwide Car and Van rental from our latest model range. Contact your local Ford Dealer for more information.

Ford Motability Call our Ford Motability team on 0345 6040019

* year 1 - unlimited mileage

* Subject to terms and conditions



Frozen White
Solid body colour



Race Red
Solid body colour



Blazer Blue
Solid body colour



Tectonic Silver
Metallic body colour*



Stratosphere
Metallic body colour*



Deep Impact Blue
Metallic body colour*



Magnetic
Metallic body colour*



Moondust Silver
Metallic body colour*



Lunar Sky
Metallic body colour*



Shadow Black
Mica body colour*

*Metallic and mica body colours are optional at extra cost.
The Ford Transit is covered by the Ford Perforation Warranty for 12 years from the date of first registration. Subject to terms and conditions.
Note The vehicle images used are to illustrate body colours only and may not reflect current specification. Colours and trims reproduced within this brochure may vary from the actual colours, due to the limitations of the printing processes used.

Special Vehicle Options (SVO)

While the Ford Commercial Vehicle range already offers an extensive choice of off-the-shelf features and options, the Special Vehicle Options (SVO) programme goes a step further. Practical options range from heavy-duty batteries to a choice of over 100 colours to match your company’s livery.

For more information, please speak to your local Ford Transit Centre.

Zinc coating Phosphate coat Electrocoat Top coat Clearcoat

12-year perforation warranty

Transit owes its durable exterior to a thorough multi-stage painting process. From the wax-injected steel body sections to the hard-wearing top coat, new materials and application processes ensure it will retain its good looks for many years to come.



Colour and trim

Choose the body colour that you think best reflects your business brand.



Base
Traxon seat insert in Charcoal Black
Max seat bolsters in Charcoal Black



Base
Artec Vinyl seat insert in Pewter†
Prima Vinyl seat bolsters in Pewter†



Trend
Lane seat insert in Charcoal Black
Max seat bolsters in Charcoal Black

Allergy-friendly interior

The new Transit interior uses materials that minimise the risk of an allergic reaction. Models fitted with air conditioning also have a high-performance pollen filter to prevent dust and pollen entering the passenger compartment.

†Option for Base only



MY 2017.25 GBR en

Illustrations, descriptions and specifications. This catalogue was correct at the time of going to print. However, Ford policy is one of continuous product development. The right is reserved to change specifications, colours and prices of the models and items illustrated and described in this publication at any time. For the latest details always consult your Ford Dealer. **Optional equipment.** Throughout this publication, wherever a feature is described as being an 'Option' or 'Option Fitment/Pack' etc, you should assume that it will be at extra cost to the base vehicle, unless specifically stated to the contrary. All models and colour combinations are subject to availability. **Note.** Some images portrayed are of a pre-production model and/or are computer generated, therefore, the design/features on the final version of the vehicle may differ in various respects. In addition, some of the features shown on the vehicles may be optional. **Note.** This brochure contains both original Ford accessories as well as a range of products from our suppliers. †The identified accessories are carefully selected third party supplier branded accessories which do not come with a Ford warranty but are covered by the third party supplier's own warranty, the details of which can be obtained from your Ford Dealer. **Note.** The Bluetooth® word mark and logos are owned by the Bluetooth SIG, Inc. and any use of such marks by Ford Motor Company is under licence. The iPod word mark and logos are the property of Apple Inc. Other trademarks and trade names are those of their respective owners. **Note.** Some driver assistance features and safety features described in this brochure are designed to function using sensors, whose performance may be affected under certain weather or environmental conditions.

The Government fuel figures do not express or imply any guarantee of the fuel consumption of any particular vehicle. The vehicles themselves have not been tested and there are inevitably differences between individual vehicles of the same model. In addition, a vehicle may incorporate particular modifications. Furthermore, the driver's style and road and traffic conditions, as well as the extent to which the vehicle has been driven and the standard of maintenance, will affect its fuel consumption. **Insurance groups** are only as recommended by the Association of British Insurers. You should always consult your insurance adviser for confirmation.



Ford and BP – working together to reduce fuel consumption and emissions.



When you have finished with this brochure please recycle it.

Ford One Call

In the unlikely event that your Ford Dealer can't help you or if you need to speak to us directly, call 0203 564 4444

Ford Rental - local service nationwide

Car and Van rental from our latest model range. Contact your local Ford Dealer for more information

Ford Motability

Call our Ford Motability team on 0345 6040019

Finance

Ford Credit Customer Services 0345 712 5490
Ford Lease Customer Services 0344 600 1405
Calls to 0344 and 0345 numbers are charged at the same rate as a standard 01 or 02 geographic number, even when calling from a mobile.

Published by Ford Motor Company Limited, Brentwood, Essex, England. Registered in England No. 235446.

FA 1576/4

BJN 204571. FoE H58E.
PN 677512/0217/4m/GBR en
January 2017.

© Ford Motor Company Limited.
www.ford.co.uk